

Graseby 1500 Infusion Pump User Manual

Version: 1.1

MDKMed Medical Technology Co., Ltd.
2024.7.5

Contents













1. Symbols, Graphics and Warnings	4
1.1. Descriptions of Graphics and Symbols	4
1.2. Warning	5
2. Terms and definitions	9
3. Brief Introduction and Scope of Application	10
3.1. Brief Introduction	10
3.2. Intended Use	10
3.3. Model Naming	11
3.4 Benefits	11
4. Important Features	11
5. Specifications	12
5.1. Basic Specifications	12
5.2. Main Performance	13
5.3. Main Functions and Common Functions	15
6. Structure and Operation Interface	16
6.1. Structural Composition	16
6.2. Display and Operation Interface	19
7. Operation Instructions	19
7.1. Installation of Infusion Pump	20
7.2. Power on and Device Safety Self-test	20
7.3. Quick Use Guide	21
7.4. Pause or Stop Infusion	26
7.5. Bolus	27
7.6. Lock and Unlock Screen Function	28
7.7. Infusion Mode Selection and Setting	28

7.7.10 transfusion mode	38
7.8. View Log	39
8. Alarms	40
8.1. Door Open Alarm	43
8.2. IV-Set Setup Fail Alarm	44
8.3. Occlusion Alarm	44
8.4. End Of Infusion Alarm	45
8.5. Air-in-line Alarm	45
8.6. Battery Empty Alarm	46
8.7. Battery & External Power Disconnect Alarm	47
8.8. Motor Error Alarm	47
8.9. Communication Error Alarm	47
8.10. Battery Error Alarm	48
8.11. KVO Alarm	48
8.12. KVO End Alarm	49
8.13. Standby End Alarm	49
8.14. No AC Power Alarm	49
8.15. Call Back Alarm	49
8.16. Low battery Alarm	50
8.17. Near End Of infusion Alarm	50
9. System Parameter setting	51
9.1. Bed number	51
9.2. Brightness	51
9.3. Alarm Sound Volume	52
9.4. Bolus Setting	52
9.5. Air Bubble Detection Sensitivity	52
9.6. Purge Setting	53
9.7. Occlusion Pressure Level	53

9.8. Screen Lock Time	54
9.9. KVO Setting	54
9.10. Near End Of Infusion Time Setting	55
9.11. Call Back Time Setting	55
9.12. Prime prompt switch	55
9.13. History mode switch	56
9.14. IV set brand	56
9.15. Night mode Setting	56
9.16. Date/Time Setting	57
9.17. Maintenance	58
10. Accuracy Calibration for IV infusion set	58
10.1. Accuracy Calibration for IV infusion set	58
11. Precautions for Using Disposable Consumables	59
12. Technical Specification	60
13. Restore to factory setting	63
14. Use, Maintenance and Removal of the Internal Battery	64
15. Service and Maintenance	64
16. Waste Disposal	66
16.1. Battery	66
16.2. IV infusion set	66
16.3. Infusion pump	66
17. Electromagnetic Compatibility	66
18. Antistatic Precautions	70
19. Network Security Notes	71
20. Packaging and Accessories	73

1. Symbols, Graphics and Warnings

1.1. Descriptions of Graphics and Symbols

	<p>Caution</p>		<p>Read the User Manual</p>
	<p>Type CF equipment</p>	<p>RoHS</p>	<p>Compliant to ROHS standards</p>
	<p>Date of manufacturing</p>		<p>Class II device</p>
	<p>Serial Number</p>		<p>Classified collection, uncontrolled discard not allowed</p>
<p>IP24</p>	<p>Ingress Protection Grade</p>		<p>AC (Alternating Current)</p>
	<p>DC (Direct current)</p>		<p>Mute</p>
	<p>European Representative</p>		<p>Manufacturer</p>

1.2. Warning

Please read the following information carefully, operation that does not strictly follow the guidance will possibly damage the device or do harm to patients' health.

- 1) The infusion pumps are intended for the intermittent or continuous delivery of parenteral fluids, enteral fluids, medications, blood and blood products through clinically accepted routes of administration. The devices can be used together with liquid storage devices /IV infusion sets /Blood transfusion sets /Enteral feeding sets.
- 2) Untrained personnel are not allowed to operate the device. The operator must carefully read this User's Manual, so as to prevent medical accidents caused by improper operation.
- 3) To prevent fire or explosion, it is forbidden to use this equipment in an environment where flammable or explosive matters are present.
- 4) The operator must use the recommended IV infusion set calibrated in accordance with the requirements described in Section 10 Accuracy Calibration for IV infusion set in this guide, and ensure that the correct IV infusion set brand and type are selected.
- 5) The IV infusion set that is not recommended should never be used for infusion, otherwise it may lead to large infusion inaccuracy and even to become unusable.
- 6) The installation height of this equipment should not be more than 1 meter above or below the patient's heart.
- 7) It is forbidden to reuse the same IV infusion set on another infusion device.
- 8) This device cannot be used as a portable device.
- 9) It is forbidden to use sharp objects to press on the buttons or the touch

screen.

- 10) The Infusion Pump must be serviced and calibrated by trained professional technicians. Before maintenance, make sure to unplug the power cable that supplies power to the equipment. Untrained personnel are strictly prohibited from opening the equipment casing, otherwise the eligibility for warranty of the equipment will be lost.
- 11) Please make sure to use only the parts and accessories provided by MDK.
- 12) When hit hard or dropped, the pump should not be used until it has been checked by trained technical staff.
- 13) Except for wiping the outer surface of the equipment according to Section 15 Service and Maintenance in this manual, no other part of the equipment shall be serviced or maintained by users. If there is any abnormality in the equipment, please contact the customer service of MDK.
- 14) After loading the IV infusion set, the operator is required to check whether the liquid medicine in the IV infusion set leaks. If there is leakage, stop using the IV infusion set and notify the customer service of MDK.
- 15) Operator should set the infusion parameters strictly based on the doctor's prescriptions. Mistakes in infusion parameter settings may cause harm to patients.
- 16) In order to maintain a high infusion accuracy, the contacting spot of compression on an IV infusion set should be changed every 8 hours. When the MDK IV infusion set is used, the IV infusion set should be changed every 48 hours to maintain a high accuracy of infusion.
- 17) To maintain high infusion accuracy, the pump needs to be re-calibrated when there is a significant change in ambient temperature.

- 18) The pump will stop operation automatically when there is an alarm. Press the Start-Stop key or click the start button to resume operation after the alarm causing condition is removed.
- 19) To avoid failure or false alarm caused by a dirty occlusion sensor or air- in-line sensor, operator should wipe clean the pump on a regular basis to keep it clean.
- 20) If the sound pressure level of the audible alarm is less than the environmental noise, the operator should turn the alarm volume up to ensure the alarm sound can be heard.
- 21) Pump or accessories may not be usable if their lifetime for use has expired (the lifetime for pump is 8 years). Contact MDK to upgrade to new products.
- 22) The device has a internal rechargeable lithium batter and its lifetime is 2 years.
- 23) Please check the voltage of the internal battery before using it for pump operation. The battery must be replaced and maintained by trained technical personnel in accordance with Section 14 Use, Maintenance and Removal of the Internal Battery in this manual. Replacing the battery by personnel without sufficient training will lead to risks such as over temperature, fire or explosion.
- 24) Please do not connect any other device to the USB and type-c port other than the included DC power adapter shipped with the pump.
- 25) Healthcare professional should check on the equipment during operation on a regular basis, and he/she should also pay attention to medication solution in the IV infusion set before starting the equipment to make sure the right medicine is in the right infusion channel.
- 26) Please use the roller clamp and other components on the IV infusion set correctly based on the corresponding instruction of the

consumable per sec.

- 27) When using this equipment, please do not plug the power to somewhere that is difficult to plug or unplug. Use an independent power outlet as a measure in case quick disconnection is needed.
- 28) IV infusion set needle is the application part of this product.
- 29) While in normal operation, an alarm will be triggered if the pump door is opened. Please contact MDK for service if this alarm fails to appear.
- 30) If the sticker on the screw hole is removed, then consider the fact that the pump has been tampered with, and discontinue use.
- 31) Don't near active HF SURGICAL EQUIPMENT and the RF shielded room of an ME SYSTEM for magnetic resonance imaging, where the intensity of EM DISTURBANCES is high.
- 32) Use of this equipment adjacent to or stacked with other equipment should be avoided because it could result in improper operation. If such use is necessary, this equipment and the other equipment should be observed to verify that they are operating normally.
- 33) Use of accessories, transducers and cables other than those specified or provided by the manufacturer of this equipment could result in increased electromagnetic emissions or decreased electromagnetic immunity of this equipment and result in improper operation.
- 34) Portable RF communications equipment (including peripherals such as antenna cables and external antennas) should be used no closer than 30 cm (12 inches) to any part of the Graseby 1500, including cables specified by the manufacturer. Otherwise, degradation of the performance of this equipment could result.
- 35) The EMISSIONS characteristics of this equipment make it suitable for use in industrial areas and hospitals (CISPR 11 class A). If it is used in a residential environment (for which CISPR 11 class B is normally

required) this equipment might not offer adequate protection to radio-frequency communication services. The user might need to take mitigation measures, such as relocating or reorienting the equipment.

- 36) The ME EQUIPMENT or ME SYSTEM is suitable for professional healthcare facility environments.
- 37) If the device needs to be used on the move (transport within the hospital) : make sure the device is securely fixed and placed. If the device is changed in position, or the pump is severely shaken, the accuracy of the infusion may be affected.
- 38) Do not use unapproved cleaners, materials or chemicals as they may damage device surfaces, labels, or cause equipment failures.
- 39) Do not route LVP supply bag or administration set right above the pump.
- 40) Do not route the administration set in a way that presents tripping hazard and administration set break off.
- 41) Do not change the height of pump during infusion, otherwise the infusion accuracy may be affected.
- 42) For different types of patients, different occlusion pressure Level should be set. For details, please refer to the doctor's advice.
- 43) When the equipment is powered by the internal battery, the charging indicator light is blue; When the device is powered through the net power supply, the external power indicator light will turn green. At this time, if the battery is not fully charged, the charging indicator light will turn green at the same time, and the charging indicator light will not turn on when the battery is fully charged.

2. Terms and definitions

Operator: A professionally trained and qualified member of medical

staff.

Keep vein open (KVO): After infusion is completed based on the preset parameters, the pump will automatically switch to a mode with extremely low Infusion rate and continue to run (this mode virtually does not have any treatment effect), which is to keep the IV infusion set and vein unobstructed and to avoid the blood flowing backwards.

Intermediate rate: An Infusion rate of 25.00 mL/h.

Minimum rate: An Infusion rate of 1.00 mL/h.

Free-flow: Drug solution is flowing out in an uncontrolled manner under the effect of gravity.

VTBI: Volume to be infusion.

3. Brief Introduction and Scope of Application

3.1. Brief Introduction

The Infusion pump is a high-accuracy infusion device. It is mainly consisted of an electrical control module and a mechanical actuation module, including subsystems such as a control system, a motor driver system, a sensing and monitoring system, an alarm system, a display system, a power system (Adapter) and etc..

3.2. Intended Use

Intended use: The Infusion pump is intended for the intermittent or continuous delivery of parenteral fluids, enteral fluids, medications, blood and blood products through clinically accepted routes of administration. It is used together with liquid storage devices /IV infusion sets/ Blood transfusion sets /Enteral feeding sets.

Indication for use: N/A.

Contraindications: not known.

Intended patient population: The target population is adults, pediatrics (including newborns) who need intravenous therapy, blood transfusion and enteral nutrition, no other specific requirements.

Intended users of the device: The device is intended to be used by trained healthcare professionals in medical institution environments.

3.3. Model Naming

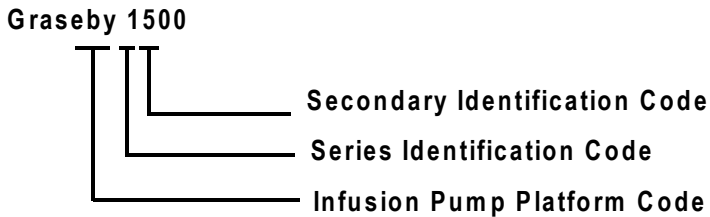

3.4 Benefits

Since the infusion pumps do not come into contact with patient directly, they don't have direct clinical benefit to patients. So the clinical benefit of the infusion pump is that the device enables the precisely administration of intravenous fluid /blood /blood product /enteral fluid procedure to be undertaken, and realizes the monitoring of the infusion processing (the device is able to send alarms during infusion process when occlusion or other circumstances), which can greatly increase the infusion safety.

4. Important Features

- 1) **Accuracy:** The accuracy for infusion rate and volume both are kept within 4%.
- 2) **Flow rate:** The Infusion rate can be adjusted from 0.01 mL/h to

2000.00 mL/h in a continuous manner, which makes the infusion pump capable of meeting various flow rate requirements in different infusion situations.

- 3) **External power supply:** An external power adapter is used, which not only removes the safety concerns of using an internal switching power source but also makes the device lighter and smaller in size.
- 4) **Battery capacity:** The rechargeable internal high-capacity Lithium battery can support normal operation for 6 hours, which is conveniently helpful during patient transport or power outage.
- 5) **Display:** LCD touch screen display offers high contrast, great visibility and user friendly usability.

Occlusion Alarm: Both upstream and downstream occlusion alarms are available, 10 pressure level is adjustable.

- 6) **Air-in-line alarm:** Based on ultrasonic technology, the device is capable of detecting air bubble sizes down to 25µL and initiating air-in-line alarm.

5. Specifications

5.1. Basic Specifications

Dimensions	119 mm×84 mm×159 mm (width x depth x height)
Weight	1.0 kg
Power supply	Network power supply: ~ 100 V-240 V, 50/60 Hz Internal battery:  7.4 V rechargeable Lithium battery
Rate of work	55 VA
Consumable requirements	Refer to Section 11 Precautions for Using Disposable Consumables

Maximum Infusion Rate	2000.00 mL/h
-----------------------	--------------

5.2. Main Performance

Infusion Rate range	0.01 ~ 2000.00 mL/h with resolution of 0.01 mL/h
VTBI range	0.01 ~ 9999.99 mL with resolution of 0.01 mL
Infusion accuracy	±4.0%
Purge Rate / Bolus Rate	1 mL/h ~ 2000 mL/h, with resolution of 1 mL/h
Purge VTBI / Bolus VTBI	0.10mL ~ 100.00mL with resolution of 0.01 mL
KVO Rate	<p>Constant KVO: Infusion rate 0.10mL/h ~ 5.00mL/h, step by 0.01mL/h</p> <p>When the Infusion rate is greater than the user-defined KVO Rate, the system runs at the user-defined KVO Rate. When the Infusion rate is less than the user-defined KVO Rate, KVO Rate = Infusion rate.</p> <p>Variable speed KVO: Infusion rate 0.10mL/h ~ 5.00mL/h, step by 0.01mL/h</p> <p>When the Infusion rate is > 10 mL/h, run at the user-defined KVO Rate > 10 mL/h.</p> <p>When 1 mL/h < Infusion rate ≤10 mL/h, the user-defined KVO Rate of 1 mL/h < Infusion rate ≤10 mL/h is used.</p> <p>When the Infusion rate is ≤1mL/h, the KVO Rate defined by the user is ≤1mL/h.</p>

	When the infusion rate is lower than the user-defined KVO rate, KVO rate = infusion rate.
Infusion Time range	00:00:00~99:59:59, with resolution of 1 s.
Occlusion threshold	10 levels, with the lowest being 30 kPa \pm 20 kPa, and the highest being 120 kPa \pm 20 kPa.
Maximum infusion pressure generated by the device	140 kPa
Occlusion alarm trigger time and Bolus dosage	<p>When operated at minimum Infusion rate(1.00mL/h): < 13min when the occlusion alarm pressure threshold is set to the lowest pressure; or < 45min when the occlusion alarm pressure threshold is set to the highest pressure.</p> <p>When operated at intermediate rate(25.00mL/h): < 1min30s when occlusion alarm pressure threshold is set to the lowest pressure, and the Bolus produced during occlusion is < 0.20 mL; < 2min30s, when the occlusion alarm pressure threshold is set to the highest pressure, the Bolus during occlusion is not more than 0.40 mL.</p> <p>(Tested with the Hanaco IV infusion set when an occlusion was created 1 meter away from the pump outlet for testing purpose at 20 °C)</p>
Consumable brand	IV infusion set: 5 brands are recommended, and the default brand is Hanaco, JR, Kindly, Kang Jin,

	<p>Shinva. 10 brands can be customized.</p> <p>enteral feeding set: MDK</p> <p>blood transfusion set: Terumo</p>
Supported Infusion modes	11 modes, RVT mode, Drug Library mode, Loading Dose mode, Micro mode, Dose mode, Drop speed mode, RTM mode, Sequence mode, Intermittent mode, Feeding mode, Transfusion Mode.
Battery running time	<p>Intermediate speed: When fully charged, the battery can run continuously for 6h30min.</p> <p>Maximum speed: When fully charged, the battery can run continuously for 6h10min.</p>
Alarm Mute Time	2 min \pm 10s
Call Back Time	1 min ~ 60 min \pm 10s
Classification	Type II CF continuous operating volumetric Infusion pump with internal power supply; Grade IP24.
Ambient temperature and humidity	<p>Ambient temperature of transportation and storage: -20 °C ~ + 55 °C</p> <p>Ambient temperature for operation: 10°C ~ + 40 °C</p> <p>Ambient humidity for transportation, storage and operation: 20% ~ 90%</p> <p>Ambient pressure for transportation, storage and operation: 700 hPa ~ 1060 hPa</p>
Software version	1500_V1
Service lifetime	8 years

5.3. Main Functions and Common Functions

- 1) Set infusion rate, infusion VTBI and real-time data display function;

- 2) Display of completed infusion volume;
- 3) Purge / Bolus;
- 4) Alarms;
- 5) The Infusion rate will be automatically changed to KVO Rate after the VTBI complete alarm is activated
- 6) Temporary mute for alarm sound and timer for alarm sound recovery;
- 7) Automatic free-flow stopping function;
- 8) Displays the accumulated quantity infusion and supports clearance
- 9) A variety of brands for IV infusion set are supported;
- 10) Built-in battery;
- 11) External power adapter;
- 12) Contains Dose-Error Reduction Software

6. Structure and Operation Interface

6.1. Structural Composition

The structure of the equipment consists of a pump casing, a motor drive system, an input system, a storage system, a control system, a display system, a sensing and monitoring system, an alarm system and a power supply system.

Names for parts and components:

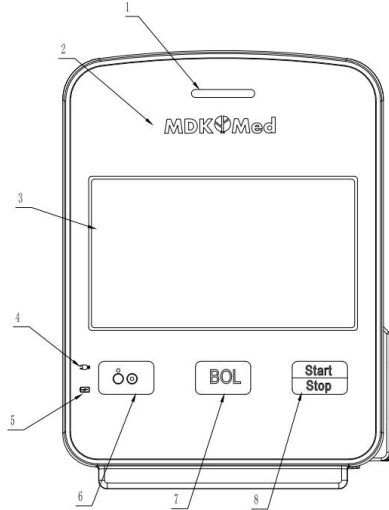

Figure 6-1-1 Front view

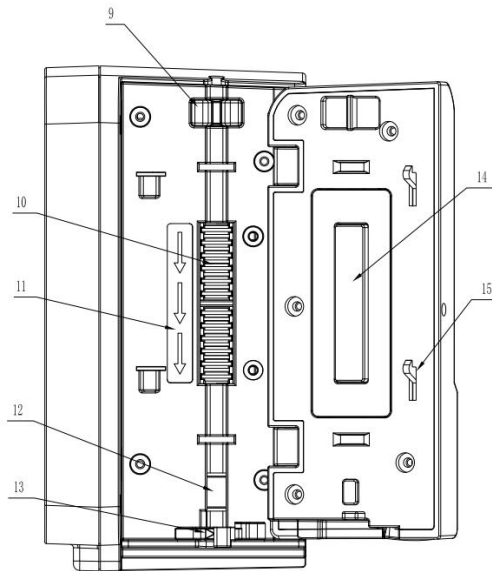

Figure 6-1-2 Side view

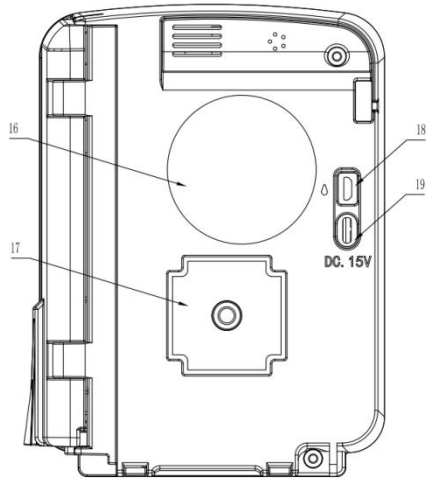

Figure 6-1-3 Side view

1	Operation status indicator	11	Direction of infusion tube installation
2	logo	12	occlusion sensor
3	Touch screen display	13	Clamp
4	External power indicator	14	spring bearer plate
5	Charging indicator	15	Door lock catch
6	Power on/off key	16	Speaker
7	Purge/Bolus key	17	Mounting bolt
8	Start-Stop key	18	Drop sensor port
9	Air bubble sensor	19	DC Power port
10	Peristaltic Sheet		

6.2. Display and Operation Interface

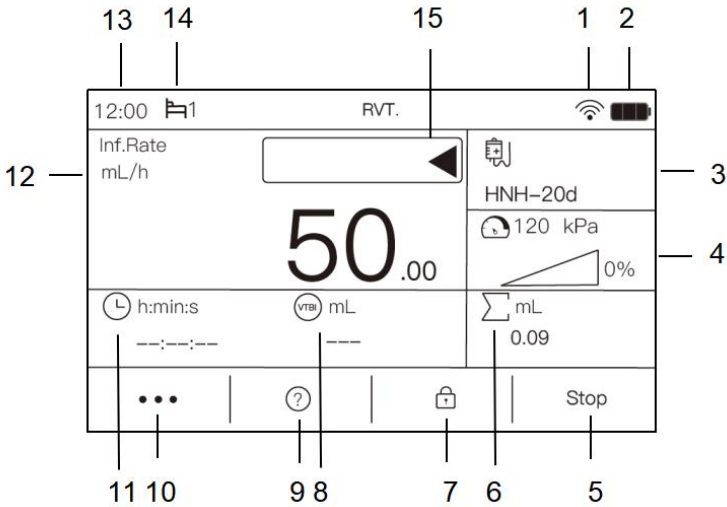

Figure 6-2 Operation interface on the screen

1	Wi-Fi	9	More information
2	Battery	10	More
3	IV Set brand	11	Time remaining
4	Occlusion pressure	12	Rate
5	Start/Stop button	13	Time
6	Infused volume	14	Bed number
7	Lock screen	15	Infusion state
8	Remaining volume		

7. Operation Instructions

Install Infusion pump → Power on → Device safety self-test →
 Install IV infusion set → Select IV infusion set brand → Parameters

setting → Prime / Purge → Start infusion → Infusion completed →
Remove accessories → Power off.

Before infusion starts, please confirm that the IV infusion set in use matches the current IV infusion set setting selected in the menu. Any IV infusion set which brand is not included in the list of recommended brands must be calibrated before being used.

7.1. Installation of Infusion Pump

First loosen the locking screw, install the clamp to the pole of the infusion stand, adjust the height of the clamp, and then tighten the locking screw. The operator must make sure that the Infusion pump is positioned in a secure, stable and reliable manner.

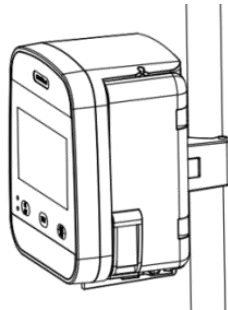

7.2. Power on and Device Safety Self-test

7.2.1. Power on and off

Before connecting to the mains power, check if there is any foreign matter inside the power outlets (such as drug solution residue).

Connect to the mains power, check the power indicator on the pump front panel. If the indicator is not lit up, check the connection of power cable and the pump, or check if there is a power outage. Then press the power Key on the front panel to turn the device on.

After infusion therapy is completed, press the power key and click Power-Off button to turn the device off. Do not power off when the device is in operation mode, otherwise the infusion therapy will be stopped.

7.2.2. Device safety self-test

Device safety self-test: The pump will perform an automatic safety self-test after powered on, if the test is passed then there will be two short beeps and the operation status indicator will be lit up in stable green color. If a continuous alarming sound is initiated or there is no any sound at all, then the device cannot be used, please contact the customer service immediately.

7.3. Quick Use Guide

7.3.1. Install / Replace IV infusion set

First, open the pump door, press the clamp upward to make the clamp open. Straighten the infusion line below the drip chamber and place it into the positioning groove. Then close the pump door, adjust the roller clamp on the IV set to its open position. The installation of IV set is completed.

Before changing IV infusion set or changing drug solution, the roller clamp on the IV infusion set has to be turned to the closed position to prevent free flow of the medication solution.

As disposables, IV infusion set must be replaced after being used for once.

To change or re-install the IV infusion set, first open the pump door, push the clamp inside pump door upward to open it and to release the infusion line. Install the IV infusion set back into the pump again, and

adjust the roller clamp on the set to the open position after the IV infusion set installation is done.

7.3.2. Select IV infusion set

After the infusion pump is powered on and the safety self-test is passed, the parameter setting page will show up. Click the Brand button in the upper right corner to enter the IV infusion set brand selection page.

After clicking an IV infusion set brand to make a selection, the system will automatically return to the parameter setting page. Please check if the IV infusion set displayed on the right side of the screen matches the set that is being used.

It is possible that the IV infusion set from the same brand may have different characteristics if they are from different lots, which will affect their infusion accuracy if they are not calibrated before use. In that case, calibration of the IV infusion set is recommended, which is described in Section 10.2 Accuracy Calibration for IV infusion set.



Figure 7-3-2 IV infusion set brand confirmation

7.3.3. Set infusion parameters

General method:

When the infusion pump is standby, click "☒" on the touch screen to enter the RVT mode parameter setting interface. Click "Inf. rate" on the touch screen, a numeric button board appears on the screen, click to enter the value of the Infusion rate to be set, and press "√" on the screen to complete the input.

Setting the VTBI and infusion time is the same as setting the infusion rate above. After all parameters are set, click the "√" button to confirm the parameters.

Quick setting method:

When the infusion pump is standby, click "Inf. rate" value on the screen, and a numeric button board appears. Click to enter the value of the Infusion rate to be set, and press "√" on the screen to complete the input.

RVT.		
Inf. Rate	---	mL/h
VTBI	---	mL
Inf. Time	--:--:--	H:M:S
✓	<	>
↶		

Figure 7-3-3-1 Set infusion parameters

1	2	3	⌫
4	5	6	↶
7	8	9	✓
.	c	0	

Figure 7-3-3-2 Input values using keypad

7.3.4. Purge

When the pump is standby, confirm that the tube is disconnected from the patient. Click the Bolus button, the device pops up “Please disconnect tube!”, after clicking “✓” on the touch screen, the device will run at the Purge rate and Purge VTBI set by the system, quickly purge the air in the infusion pipeline. Press the start/stop key or click the pause button can stop purging. Repeat until there are no bubbles.

The purge volume is not included in the Infusion accumulation. When the Purge is running, the Air-in-line alarm is not suppressed, and the other alarms are normal.

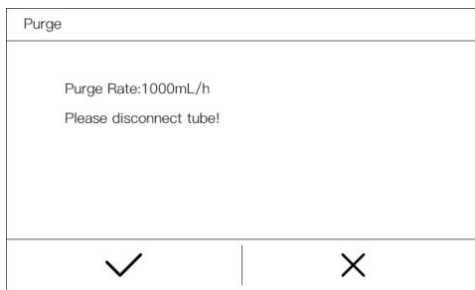

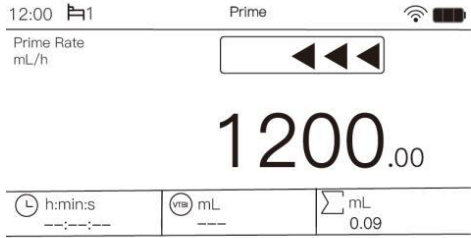

Figure 7-3-4 Purge

7.3.5. Start infusion

Press the Start/Stop key or click the start button and the pump will start to run according to the set infusion parameters, as shown in the following figure.

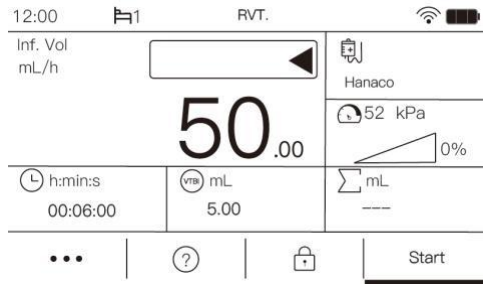

Figure 7-3-5 Infusion operation interface

7.3.6. Infusion completed

The infusion is completed when the infusion accumulation volume reaches the VTBI set for the infusion task.

If KVO is enabled, the device will convert to the KVO Rate to continue running automatically and trigger the "Enter KVO" high priority alarm at the same time, make an alarm sound. Click the "√" on the screen to exit the KVO infusion status.

If KVO is disabled, the device will trigger the "End Of Infusion"

alarm, accompanied by an high priority alarm sound. Click the "√" on the touch screen eliminates alarm.

After the infusion is completed, remove the infusion accessories that are no longer used following the steps described in Section 7.3.1. Press the power on/off key, click power-off button to turn off the device. Pull the ring on the base of the mounting clamp upward and pull the infusion pump body outward to remove it.

7.4. Pause or Stop Infusion

Infusion normal operation status see Figure 7-3-5.

Press the Start/Stop key or click the stop button during infusion operation can pause the operation, as shown in the following figure.

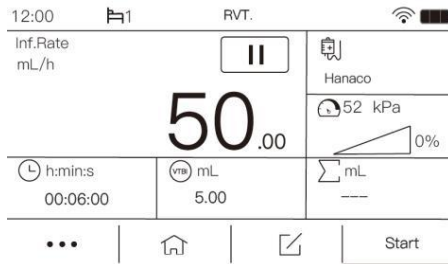

Figure 7-4 Infusion pause

On the Infusion pause page, press the Start/Stop key or click the start button again can start the device operation, and the device will continue to infuse the remaining volume based on the set Infusion rate.

During the infusion pause, any parameter of the Infusion rate, VTBI, and Infusion time is modified will be considered a new infusion task, and when press the Start/Stop key or click the start button again, the infusion task will be completed according to the new infusion parameters.

When the device triggers the alarm, makes an alarm sound, presses the "Mute" button on the screen can pause the alarm sound, and after 2 minutes, if the alarm source is not lifted, the alarm sound is automatically restored.

7.5. Bolus

7.5.1. Hand off bolus

In the infusion operation state, press the Bolus key or click the "BOL" button, enter the Hand Off Bolus page, set the bolus parameters, click the "√" button, the infusion pump enter into bolus infusion state until the bolus VTBI is completed, the infusion pump returns to the normal infusion state continue the infusion, the bolus volume is included in the infusion accumulative volume.

Hand Off Bolus		
Bolus Rate	---	mL/h
Bolus VTBI	---	mL
Bolus Time	--:--:--	H:M:S
✓		↶

Figure 7-5-1-1 Bolus Settings interface

12:00	1	RVT.	Wi-Fi	Battery
Bolus Rate mL/h		<input type="text" value="2000.00"/>		
⌚ h:min:s 00:00:09	Ⓢ mL 5.00	∑ mL ---		
⋮	?	🔒		

Figure 7-5-1-2 Bolus running interface

7.5.2. Hand-On bolus

In the infusion operation state, long press the Bolus key, the infusion pump enters bolus infusion state, and runs according to the rate set in "Setting - Bolus - Bolus Rate". Release the bolus key to stop the bolus infusion, and the infusion pump returns to the normal infusion state before the bolus infusion to continue infusion, the bolus volume is included in the infusion accumulative volume.

7.6. Lock and Unlock Screen Function

The device automatically locks the screen after running for a period of time. When the device is in the lock screen, click the screen and a prompt will pop up asking whether to unlock the screen, click the "√" button to unlock the screen.

Auto Lock time settings See Home - Setting - Auto Screen Lock.

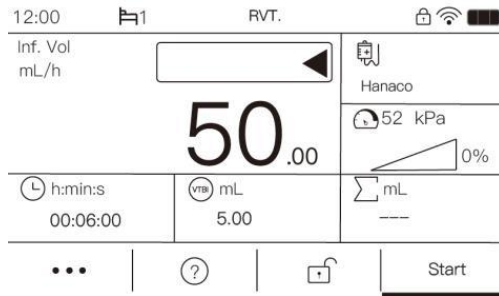

Figure 7-6 Lock Screen

7.7. Infusion Mode Selection and Setting

Except for the RVT mode on the home screen, there are 10 infusion modes on the Infusion Mode page: Dose mode, Drug Library mode, Drop speed mode, RTM mode, Sequence mode, Loading Dose

mode, Intermittent mode, Micro mode, Feeding mode, Transfusion mode,.

Inf. Mode	1/2
RVT.	Drug Library
Loading Dose	Micro
Dose	RTM
Sequence	Intermittent

Figure 7-7 Infusion Mode

In the RVT setting page, the infusion rate, VTBI and infusion time can be set in a variety of combinations, forming the following four combinations of infusion mode: rate + volume (R+V) Mode , rate + time (R+T) Mode, volume + time (V+T) Mode, rate (R) Mode. Therefore, there are 12 different infusion modes for the device in total.

The setting of the RVT mode should follow the instructions in the 7.3 "Quick Use Guide" above. The settings for the other modes are outlined below.

7.7.1. Dose mode

Enter the Dose mode settings interface, as shown in Figure 7-7-1. After setting the Dose, Solution, Concentration, Dose Rate, Weight, VTBI and Infusion Rate, click "√" to confirm the parameters.

In the main interface of Dose mode, click the "unit" in the upper left corner to switch the display of "Dose Rate" and "Infusion rate".

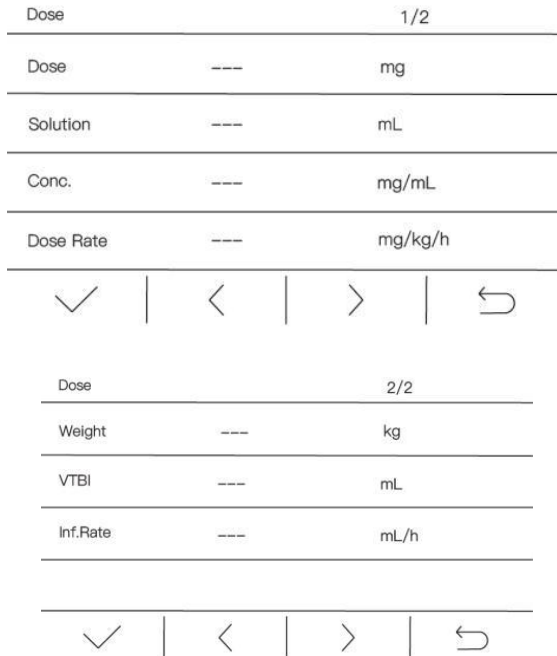

Figure 7-7-1-1 Dose mode setting

In the Dose Mode Settings interface, click "Unit" to the right of any parameter in "Dose", "Concentration" and "Dose Rate" to select different unit expression modes, and the other two corresponding units will be automatically adjusted.

Concentration and Infusion Rate are calculated as follows:

Concentration calculation formula:

$$\text{Concentration(mg/mL)} = \frac{\text{Dose (mg)}}{\text{Solution (mL)}}$$

Infusion rate calculation formula:

Infusion Rate(mL/h)

$$= \frac{\text{Dose Rate (mg/kg/h)} \times \text{weight (kg)} \times \text{Solution (ml)}}{\text{Dose (mg)}}$$

$$\text{Infusion Rate(mL/h)} = \frac{\text{Dose Rate (mg/h)} \times \text{Solution (ml)}}{\text{Dose (mg)}}$$

7.7.2. Drug Library mode

Enter the drug library mode settings interface.

Select the name and the specific specifications of the drug that requires infusion. The device will enter the drug library mode settings page and automatically brings in the drug-related parameters. At this point, the drug name and drug specifications are displayed in the title bar of the parameter settings page. After setting the parameters, click "√" to confirm the parameters.

ADREnaline		1/2	
Conc.	---	mg/mL	
Weight	---	Kg	
Dose Rate	---	mg/Kg/mL	
Inf. Rate	---	mL/h	
✓	<	>	↶

ADREnaline		2/2
VTBI	---	mL
✓	<	>
		↶

Figure 7-7-2 Drug library mode setting

The Drug library mode has built-in DERS (Dose-error Reduction Software) functionality to reduce medication errors and improve infusion safety.

7.7.3. Drop Speed mode

Connect the interface of the drop sensor to the drop sensor port of the device, and install the drop sensor on the drip pot. When replacing the sensor, remove the drop sensor, pull out the interface, and reinstall it.

The drop speed mode setting page is shown in Figure 7-7-3. After the drop speed parameter is set, the system will automatically convert it to a flow rate and display it. The other steps for the settings in this mode are the same as those in the RVT mode described in the Quick Start Guide section.

Drip		
VTBI	---	mL
Drop Rate	---	dot/min
Inf. Rate	---	mL/h
✓		↶

Figure 7-7-3 Drop Speed mode setting

The infusion pump can be used in conjunction with the matching drop sensor to monitor the flow rate in the infusion pipeline. When the drop speed deviates from the set infusion speed by 50%, an alarm will be triggered.

In order to ensure the reliability and accuracy of the drop detection, the drop sensor should be installed as close to the liquid level as possible, and the liquid level height should be 1/3 of the drip pot. During infusion, tilt of drip sensor, direct sunlight and strong light should be avoided.

For cleaning the drop sensor, please refer to the manual "15 Service and Maintenance" to wipe the external surface of the drop sensor.

7.7.4. RTM mode

RTM.		1/2	
Total Time	--:--:--	H:M:S	
Up Time	--:--:--	H:M:S	
Down Time	---:--	H:M:S	
VTBI	---	mL	
✓	<	>	↶

RTM.		2/2	
Plateau Rate	---	mL/h	
✓	<	>	↶

Figure 7-7-4 RTM mode setting

Enter the RTM mode(Ramp and Taper Mode) settings interface, as shown in Figure 7-7-4.

In the RTM mode parameters, VTBI, Up Time, and Down Time must be set. After setting one of the two parameters of Plateau rate or Total Time, the other parameter will be calculated automatically. After setting the parameters, click "√" to confirm the parameters.

When the device is started, the infusion rate gradually increases from 0 to Plateau Rate during the Up Time and then maintains the rate. When the remaining time is equal to the Down Time, the infusion rate gradually decreases until it reaches 0 and the infusion is completed.

7.7.5. Sequence Mode

Enter the Sequence Mode settings interface to set the number of sequences (up to 10 groups), click the "√" button to enter the infusion parameter settings interface, as shown below.

Sequence	1/3		
Seq. Count	1		
✓ < > ↶			

Sequence	2/3		
S1-Inf. VTBI	---	mL	
S1-Inf. Time	--:--:--	H:M:S	
S1-Inf. Rate	---	mL/h	
✓ < > ↶			

Sequence	3/3		
Total VTBI	---	mL	
Inf. Time	--:--:--	H:M:S	
✓ < > ↶			

Figure 7-7-5 Sequence Mode Setting

As shown in the figure, Set any two of the Infusion VTBI, Infusion Rate, Infusion Time, the device will automatically calculate another

parameter.

After setting infusion parameters for all sequences according to clinical needs, click "√" to confirm the parameters.

When the device completes the infusion parameters of the first sequence, it automatically switched to the parameter run of the second sequence until the set parameters of all sequences were completed and the infusion is completed.

7.7.6. Loading Dose Mode

Enter the Loading Dose mode settings interface.



Loading Dose		1/2
VTBI	---	mL
Loading VTBI	---	mL
Loading Rate	---	mL/h
Maintain Rate	---	mL/h
		
Loading Dose		2/2
Loading Time	---	mL/h
Maintain Time	--:--:--	H:M:S
		

Figure 7-7-6 Loading Dose mode setting

As shown in the figure, After setting the VTBI, Loading VTBI, Loading Rate, and Maintain Rate, the device automatically calculated the Loading Time and Maintain Time, and click the "√" button to

confirm the infusion parameters.

7.7.7. Intermittent mode

Intermittent		
Single VTBI	---	mL
Single Rate	---	mL
Inter Time	--:--:--	H:M:S
Maintain Rate	---	mL/h
✓		↶

Figure 7-7-7 Intermittent mode

Enter intermittent mode settings interface.

As shown in the figure, set the Single VTBI, Single Rate, Intermittent Time and Maintain Rate, and click the "✓" button to confirm the infusion parameters. After the device is started, the infusion will start at the Single Rate. When the infused volume is equal to the single VTBI, the device will automatically continue infusion according to the Maintain Rate. When the Maintain Rate is set to 0, the device will run at 0 mL/h. The device runs at Maintain Rate until the time is equal to the Intermittent Time, the device automatically switches to the Single Rate to continue the infusion, so as to cycle.

7.7.8. Micro mode

Enter Micro mode settings interface.

Set any two of the Infusion Rate, VTBI, and Infusion Time, the device will automatically calculate another parameter. The Infusion Rate should not exceed 100mL/h. After the device is started, the infusion starts at the Infusion Rate. When the infused volume is equal

to the VTBI, the infusion will be stopped automatically.

When only sets the Infusion Rate, the device runs at the Infusion Rate until the operator stops the infusion or the device triggers a high priority alarm to stop the infusion.

7.7.9 Feeding mode

Install the special nutrition tube according to 7.3.1 Operation instructions, and select the consumables as the special nutrition tube according to the operation instructions in Section 7.3.2. Click Home-Infusion Mode-Feeding Mode to enter the page of mode parameter setting.

According to the method of 7.3.3, set two of the three items of feeding flow rate, feeding quantity and feeding time, and the equipment will automatically calculate the third item. When the feeding flow rate is set, and the feeding quantity and feeding time are set to 0, the set speed will be run until the liquid bag is empty. After setting feeding parameters and removing Air Bubbles from Infusion Line according to 7.3.4, press the Start-Stop button or click the Start button to start the infusion.

7.7.10 transfusion mode

Install the special blood transfusion tube according to 7.3.1 Operation instructions, and select the consumables as the special blood transfusion tube according to the operation instructions in Section 7.3.2. Click Home-Infusion Mode-Transfusion Mode to enter the page of mode parameter setting.

The method for setting transfusion mode parameters is the same as that for RVT mode. The three parameters of flow rate, infusion volume and infusion time can be set to form the following four combination modes: flow rate + total volume mode, flow rate + time

mode, total volume + time mode, and RVT mode (without total volume and time).

After setting transfusion parameters and removing Air Bubbles from Infusion Line, press the Start-Stop button or click the Start button to start the infusion.

7.8. View Log

On the Home - Event Log Page, event logs such as device infusion status and alarm can be displayed. Click this event can view the detailed event information such as Infusion Rate, VTBI, time, Alarm priority and time.

When the pump log store reaches the upper limit of the pump capacity, the oldest log will be overwritten by the new log.

When the alarm system is powered off, the log still exists.

EventLog	1/2	
Low Battery	2020-01-01	>
Call Back Alarm	2020-01-01	>
Low Battery	2020-01-01	>
Low Battery	2020-01-01	>
✓	<	>
		↶

Figure 7-8-1 Event Log

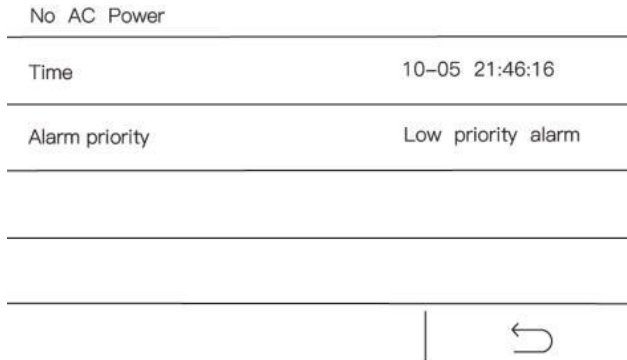

Figure 7-8-2 Alarm priority

8. Alarms

Alarm refers to the infusion changes caused by the abnormal infusion circuit or the failure of the Infusion pump itself, which leads to the failure of the infusion to the patient. The Infusion pump prompts the medical staff through sound, light, screen signs and other ways.

Alarm classification prompts of the equipment:

No.	Alarm	Priority	Alarm category	Alarm conditions
8.1	Door open	High	Latching	The pump door is not closed during operation or purge.
8.2	IV-Set Setup Fail	High	Latching	IV-Set are not properly installed.
8.3	OCCL (Occlusion)	High	Latching	When the infusion line is occluded.
8.4	End Of Infusion	High	Latching	When the infused volume reaches to the VTBI.
8.5	Air-in-line	High	Latching	Air bubbles are detected in the line.

8.6	Battery Empty	High	Latching	When the internal battery is running out.
8.7	Battery&External Power Disconnect	High	Unlatching	When the device is running, the battery and external power is disconnected at the same time.
8.8	Motor Err.	High	Latching	In the event of a motor failure.
8.9	Com. Err. (Communication error)	High	Latching	Monitor the CPU for communication handshake errors.
8.10	Battery Error	High	Latching	The device does not detect battery signal or battery disconnect when plug in the external power.
8.11	KVO	High	Latching	The infusion is complete with KVO is enabled.
8.12	KVO End	High	Latching	KVO status run for 30 minutes until the KVO task is complete.
8.13	Standby End	High	Latching	When standby is end.
8.14	No AC Power	Low	Unlatching	When the device is disconnected from the external power and operated with batteries.
8.15	Call Back	Low	Unlatching	The device is ready to start the infusion, but the device is not started and the device is placed without operation for the set time.
8.16	Low battery	Low	Unlatching	When the internal battery power is low.

8.17	Near End Of Infusion	Low	Unlatching	When the remaining time is less than or equal to the set near end of infusion time.
------	----------------------	-----	------------	---

High-priority and low-priority alarms are distinguished in sound and light according to standard requirements. When an alarm occurs, the operator can accurately detect it at 1m away from the alarm system. The delay time of triggering the alarm signal is not more than 2s.

After powering on, the status indicator lights up, and the device automatically conducts a safety check. After passing the self-check, you will hear two short beeps of "DiDi", which means that the alarm system is normal. If the status indicator does not light up or you hear a continuous alarm sound or no prompt sound after booting, it means that the alarm system is faulty and the equipment cannot be used normally. It can be put into use after being repaired.

The sound pressure range of the audible alarm signal is 60-95dB.

Note that this device prohibits access to the change or storage change alarm function. In the process of adjusting the alarm limit or alarm preset, the operation of the alarm system still runs according to the last setting. This equipment alarm is a technical alarm state.

=====



Latching alarm signal: The alarm signal that continues to be generated after the trigger event no longer exists, and does not stop until the operator deliberately acts (click the "√" button);

Unlatching alarm signal: When the related trigger event is no longer

When it exists, automatically stop the alarm signal generated.

Equipment alarm announcement sequence:

High priority alarm sound priority principle, that is, when the device is in the low priority alarm sound state, when a high priority alarm is generated, the original low priority alarm sound is interrupted, the high priority alarm sound is broadcast, and the high priority alarm sound is displayed at the same time Level alarm prompt information.

The device is in a high priority alarm. When a low priority alarm is generated, the high priority alarm continues to broadcast without being interrupted.

The device is in low priority alarm. When a low priority alarm is generated, it still reports a low priority tone and displays the latest alarm prompt information.

The device detects that a visual alarm and an audible alarm appear immediately.

When the power loss time is less than 30 seconds, the alarm settings before the power loss will automatically restore.

=====

8.1. Door Open Alarm

Cause: When the infusion pump is running, if the pump door is not closed, or the pump door is opened by accident, the device will trigger an alarm, stop running, make a high priority alarm sound, the screen appear with the message "Door Open" and the operation status indicator flash red at the same time.

Solution: Click the "√" on the screen to clear the alarm, the word "Door Open " disappears, and returns to the infusion pause interface. Check the pump, close pump door and continue to operate.

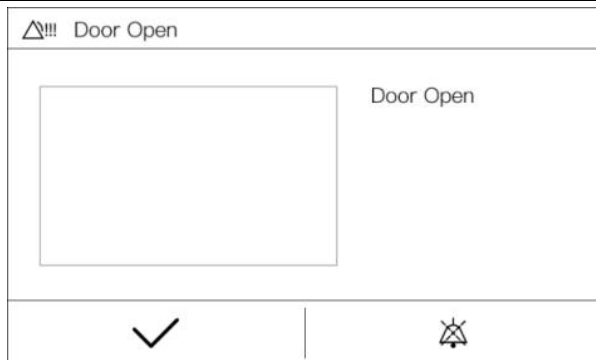

Figure 8-1 Door Open Alarm

8.2. IV-Set Setup Fail Alarm

Cause: When operation is started without an IV infusion set being installed on the pump, the device triggers an alarm, stops running, make a high priority alarm sound, the screen appears with the message "IV-Set Setup Fail" and the operation status indicator flashes red at the same time.

Solution: Click the "✓" button on the screen to clear the alarm, the word "IV-Set Setup Fail" disappears, and returns to the infusion pause interface. Open the pump door and install the IV infusion set before continuing.

8.3. Occlusion Alarm

Cause: When the infusion line is occluded, occlusion sensor detects that it is exceeding the set value, the device will trigger an alarm, stop running, make a high priority alarm sound, the screen appear with the message "OCCL" and the operation status indicator flash red at the same time.

At the same time, as a infusion safety protection mechanism, the motor reverses back to pump a small amount of liquid medicine to

reduce the dose of the bolus before occlusion relief.

Solution:

- 1) Click the "√" button on the screen to clear the alarm and the message "OCCL" disappear.
- 2) Check whether the IV infusion set line is kinked, whether the patient presses into the infusion line and other issues, eliminate the problem and restart the infusion.
- 3) If there is still an occlusion alarm, shut off the roller clamp on the IV infusion set, open the pump door, pull out the IV infusion set, check whether the filter or the needle on IV infusion set is occluded, change to a new IV infusion set if necessary and restart infusion.

8.4. End Of Infusion Alarm

Cause: If KVO is disabled, When the infused volume reaches the VTBI, the device will trigger an alarm, stop running, make a high priority alarm sound, the screen appear with the message "End Of Infusion" and the operation status indicator flash red at the same time.

As a infusion security mechanism, If KVO is enabled, the device will automatically convert to KVO Rate to continue the infusion.

Solution : Click the "√" button on the screen to clear the alarm and the message "End of Infusion" disappears. The device can be set up and used again.

8.5. Air-in-line Alarm

Cause: When the infusion pump is running, if the air-in-line sensor detects that the size of air bubble is larger than that of the preset limit, the device will trigger an alarm, stop running, make a high priority alarm sound, the screen appear with the message "Air-in-line"

and the operation status indicator flash red at the same time.

Solution:

- 1) Click the “√” button on the screen to clear the alarm and the message "Air-in-line" disappears.
- 2) To remove air bubbles from the infusion line, close the roller clamp, open pump door, take IV infusion set out, check whether there is air bubbles in the line, shake and move the air bubbles to the drip chamber by hands if there is, reinstall the IV infusion set, close the pump door, open the roller clamp, press the Start/Stop key or click the Start button to restart infusion.
- 3) Check if the air-in-line sensor is clean. If sensor probe is dirty, uninstall the IV infusion set, wipe clean the sensor probe with alcohol, reinstall the IV infusion set, and restart infusion.
- 4) If there is still an Air-in-line alarm, change to a new IV infusion set, install the IV infusion set and restart.
- 5) The air-in-line alarm will be activated too if the infusion line between the infusion bag and the pump is occluded. Remove the occlusion in infusion line and restart infusion.

8.6. Battery Empty Alarm

Cause: When the internal battery is running out, the device will trigger an alarm, stop running, make a high priority alarm sound, the screen appear with the message "Battery Empty" and the operation status indicator flash red at the same time, and the device will stop running and power off after 3 minutes.

Solution: The external power supply should be used immediately. When plugged in the external power supply, the battery charge light goes on and the battery starts charging. When the battery is fully

charged, the battery charge indicator goes out.

8.7. Battery & External Power Disconnect Alarm

Cause: When the Infusion pump is running, the external power is disconnected, and the device does not detect the battery signal or the battery is disconnected unexpectedly, the device will trigger an alarm, the screen is black, the operation status indicator flash red at the same time, and the sound and light continue to alarm for 3 minutes before the device automatically power off.

Solution: Use external power supply or battery supply, and restart the device after power supply.

8.8. Motor Error Alarm

Cause: When an error is detected in the motor feedback signal (too slow or too fast, or wrong direction of motor operation etc.), or the sensor detection of push handle position does not match the cumulative amount of infusion, the device will trigger an alarm, stop running, make a high priority alarm sound, the screen appear with the message "Motor Error" and the operation status indicator flash red at the same time.

Solution: Click the "√" button on the screen to clear the alarm. Start the infusion again, still report the fault alarm, please contact our service personnel.

8.9. Communication Error Alarm

Cause: When the communication of the device monitoring CPU is incorrect, the device will trigger an alarm, stop running, make a high priority alarm sound, the screen appear with the message "Communication Error" and the operation status indicator flash red at

the same time.

Solution: Click "√" button on the screen to clear the alarm sound. Press the Power on/off key to shut down the device and restart the device. If the fault alarm is still reported, please contact our service personnel.

8.10. Battery Error Alarm

Cause: When the external power is inserted on the device, the device does not detect the battery signal or the battery is disconnected unexpectedly, the device will trigger an alarm, stop running, make a high priority alarm sound, the screen appear with the message "Battery Error" and the operation status indicator flash red at the same time.

Solution: Click "√" button on the screen to clear the alarm sound. Press the Power on/off key to shut down the device and restart the device. If the fault alarm is still reported, please contact our service personnel.

8.11. KVO Alarm

Cause: When KVO is enabled and the infusion is complete, the device will automatically convert to the KVO Rate to continue operation. At the same time, the device will trigger high priority alarm and sound alarm, the screen appear with the message "KVO" and the operation status indicator will flash red at the same time.

Solution: Click the "√" button on the screen to clear the alarm. The message "KVO" disappear. The device can be reset according to operating steps.

8.12. KVO End Alarm

Cause: When the KVO state runs for 30 minutes until KVO task is completed, the device will trigger an alarm, stop running, make a high priority alarm sound, the screen appear with the message "KVO End" and the operation status indicator flash red at the same time.

Solution: Click the "√" button on the screen to clear the alarm. The message "KVO End" disappear. The device can be reset according to operating steps.

8.13. Standby End Alarm

Cause: When the device is in standby and the standby is over, the device will trigger high priority alarm and sound alarm, the screen appear with the message "Standby End" and the operation status indicator flash red at the same time.

Solution: Click the "√" button on the screen to clear the alarm.

8.14. No AC Power Alarm

Cause: When the device is powered on without the network power and use battery power supply, the device will trigger an alarm, make a low priority alarm sound, the screen appear with the message "No AC Power" and the operation status indicator steady on yellow at the same time.

Solution: Click the "√" button on the screen or connect to an external power supply to clear the alarm.

8.15. Call Back Alarm

Cause: The device is ready to start the infusion, but the device is not started and the device is placed without operation for the set time,

the device will trigger an alarm, make a low priority alarm sound, the screen appear with the message "Call Back" and the operation status indicator steady on yellow at the same time.

Solution: Click the "√" button on the screen to clear the alarm.

8.16. Low battery Alarm

Cause: When the internal battery is low, the device will trigger an alarm, make a low priority alarm sound, the screen appear with the message "Low Battery" and the operation status indicator steady on yellow at the same time. If the Infusion pump is infusion, the device will not stop infusion.

Solution: The external power supply should be used immediately. When plugged in the external power supply, the battery charge indicator lights up, the battery starts charging, and the message "Low battery" disappears, the battery icon shows the dynamic effect of charging. When the battery is fully charged, the battery charge light goes out.

8.17. Near End Of infusion Alarm

Cause: When the remaining time is less than or equal to the set near end of infusion time, the device will trigger an alarm, make a low priority alarm sound, the alarm indicator area at the top of the screen appear with the message "Near End Of Infusion" and the operation status indicator steady on yellow at the same time, and the Infusion pump continues to infusion does not stop.

Solution: Click the "Mute" button on the right of the alarm prompt area to suspend the alarm sound. Focus on the amount of fluid remaining in the Infusion pump and the time remaining, and wait for

the Infusion pump infusion to complete.

9. System Parameter setting

9.1. Bed number

The Bed number can be set on the Home-Setting- Bed number page.

9.2. Brightness

On the Home- Setting- Brightness page, brightness of the display can be adjusted between 1 and 10 level by clicking on the + or – sign. After brightness setting is completed, click the "✓" button to return to the previous page.



Figure 9-2 Brightness setting

9.3. Alarm Sound Volume

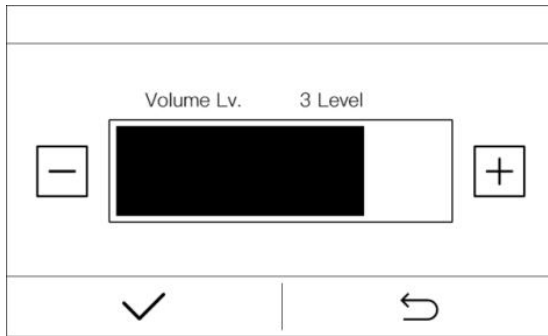

Figure 9-3 Volume setting

On the Home- Setting- Volume- page, alarm sound volume can be adjusted between 1 and 5 level by clicking on the + or – sign. After sound volume setting is completed, click the "✓" button to return to the previous page.

9.4. Bolus Setting

The Bolus Rate and Bolus VTBI can be set on the Home- Setting- Bolus page. Click the corresponding parameter value to set. After the Settings are complete, click the Back button to return to the previous page.

9.5. Air Bubble Detection Sensitivity

The Air-in-line detection sensitivity can be set the Home- Setting- Bubble page. Click on the + or - sign to adjust the sensitivity level. After setting is completed, click the "✓" button to return to the previous page.

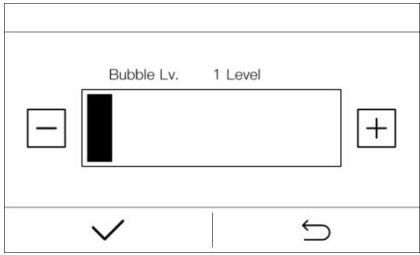

Figure 9-5 Air bubble detection sensitivity setting

The smaller the bubble level, the more sensitive it is. The minimum bubble size detectable for each level is shown in the following table:

Air Bubble Level	1	2	3	4	5	6	7	8	9
Bubble Size (μL)	25	50	100	200	300	500	800	1000	1200

9.6. Purge Setting

The Purge Rate and Purge VTBI can be set on the Home- Setting- Purge page. Click the corresponding parameter value to set. The values set in the Purge setting will not affect the Bolus Rate and Bolus VTBI.

9.7. Occlusion Pressure Level

The occlusion pressure Level can be set on the Home- Setting- Level Setting page. Click + or - sign on the screen to choose a pressure level. Click the "✓" button to return to the previous page.

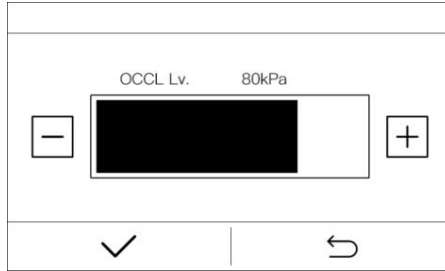

Figure 9-7 Occlusion pressure level setting

9.8. Screen Lock Time

On the Home- Setting- Auto Screen Lock page, set the Lock time for the screen and keys of the device during infusion operation.

If the screen lock time is set to 0, the Auto Screen Lock function is disabled.

You can also manually lock the device by clicking the "Lock screen" button on the screen when the device infusion is running. When the screen is locked, click the "Unlock" button on the screen to unlock it. When the screen is locked, other buttons and screen areas are unavailable except the power button and the Unlock button on the screen.

9.9. KVO Setting

On the Home- Setting - KVO page, set the KVO Mode and KVO Rate after the End Of Infusion.

Select the Constant KVO mode and the device will operate according to the currently set KVO Rate.

Select the Adaptive KVO mode, the device will automatically determine the KVO Rate level according to the current Infusion rate of the infusion operation, and run according to the KVO Rate of the

currently set Infusion rate level.

KVO example: When the device selects the Constant KVO, the Constant KVO rate is 2mL/h. When the actual flow rate is $\geq 2\text{mL/h}$, the KVO flow rate after infusion is 2mL/h. When the actual flow rate is $< 2\text{mL/h}$, the KVO running rate after infusion is equal to the actual running rate.

When the device selects variable speed KVO, the variable KVO rate: "Flow Rate > 10 " is 3mL/h, "Flow rate ≤ 10 " is 2mL/h, and "Flow rate ≤ 1 " is 0.5mL/h. When the actual flow rate is $> 10\text{mL/h}$, the KVO flow rate after infusion is 3mL/h. When $2\text{mL/h} \leq$ the actual flow rate $\leq 10\text{mL/h}$, the KVO running flow rate after infusion is 2mL/h. When $1\text{mL/h} <$ the actual flow rate $< 2\text{mL/h}$, the KVO running flow rate after infusion is equal to the actual running rate. When $0.5\text{mL/h} \leq$ the actual flow rate $\leq 1\text{mL/h}$, the KVO running flow rate after infusion is 0.5mL/h. When the actual flow rate is $< 0.5\text{mL/h}$, the KVO running rate after infusion is equal to the actual running rate.

9.10. Near End Of Infusion Time Setting

The near end of infusion time can be set on the Home- Setting- NEOI page.

9.11. Call Back Time Setting

On the Home- Setting- Call Back Time page, can set the Call Back Alarm time when the device is placed without operation and not running.

9.12. Prime prompt switch

On the Home- Setting- Prime prompt switch page, can choose whether to enable the Prime prompt, if this function is enabled, the

"Prime" prompt page will appear when a new infusion task starts after each IV infusion set change.

9.13. History mode switch

On the Home- Setting- History mode switch page, can choose whether to enable the History mode, if this function is enabled, the "Sure to load last treatment?" prompt page will be displayed after each power on.

9.14. IV set brand

When the device is not running, click the IV infusion set brand on the upper right corner of the interface, select the corresponding IV infusion set name, and the device will return to the infusion page. The selected brand for the IV infusion set will be shown on the upper right corner of the infusion page, which can remind the operator to use the right IV infusion set to maintain high infusion accuracy.

The calibration operation of IV infusion set, see Section 10.2 Accuracy calibration for IV infusion set.

9.15. Night mode Setting

Night Mode	1/2	
Night Mode Enable		<input checked="" type="checkbox"/>
Volume	3	>
Bright.	3	>
Start Time	19:00:00	>
< > ↶		

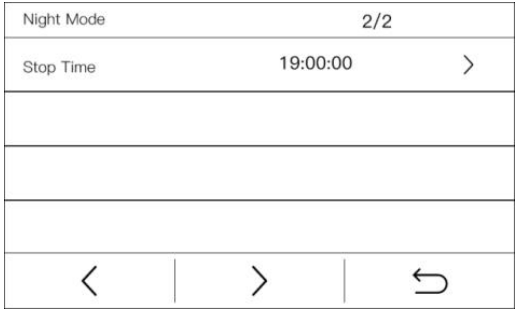

Figure 9-15 Night mode setting

On the Setting- Maintenance- Night Mode page, can set the brightness or sound volume for daytime or nighttime, the setting method is the same as that for brightness and sound level.

9.16. Date/Time Setting

The device of Time and date can be set on the Setting - Maintenance- Date/Time page.

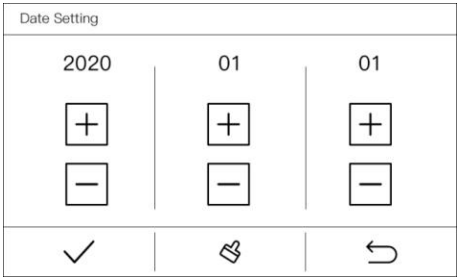
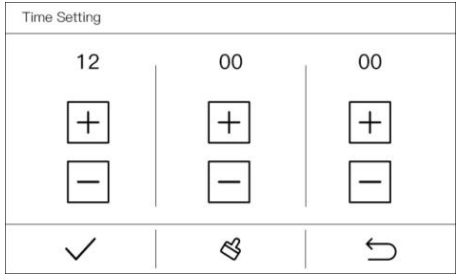

Figure 9-16-1 Date Setting



9.17. Maintenance

Maintain the device in "Setting - Maintenance", including the calibration of IV infusion set accuracy, system time settings, system language settings, factory resets, etc. Entering the Maintenance interface requires entering the engineer's maintenance password, password please consult the company's sales and service personnel.

IV infusion set calibration operation instructions see Section 10 of this manual.

10. Accuracy Calibration for IV infusion set

The brand and specification IV infusion sets that have not been calibrated, or IV infusion sets belonging to different production lots with the calibrated IV infusion sets, need to be calibrated before use. In normal use, the IV infusion set should be re-calibrated every 6 months.

10.1. Accuracy Calibration for IV infusion set

1) Same as the normal infusion operation, install the IV infusion set first, put the scalp needle into the beaker, place the beaker on the balance and clear the indicator to zero, and enter the page of "Setting-System Maintenance- Consumable Maintenance-Calibration Consumable".

2) Click Brand, select the brand of the IV infusion set to be calibrated, and return to the Calibration Consumable page.

3) Click Calibration range, select the high Rate interval or the low Rate (the calibration Rate of the low Rate is 200mL/h, and the output volume is 10mL; the calibration Rate of the high Rate is 1000mL/h,

and the output volume is 50mL), return to the Calibration Consumable page, and pay attention to the selection of the scalp needle specifications that match the rate.

4) Click Calibration Start/Stop, the infusion pump will output a certain amount of solution according to the current calibration interval. When the infusion was completed, the infusion pump automatically stopped running.

5) Check the balance reading, convert it to the actual solution volume, and input the actual solution volume in the Volume Output;

6) Turn to the next page and click OK to save the current calibration value.

11. Precautions for Using Disposable Consumables

It's suggested to use the recommended consumables. The ambient temperature should be kept at least at 10 °C or above when a recommended consumable is used. The infusion accuracy will be compromised if ambient temperature is lower than 10 °C.

The recommended consumables are listed in the table below:

No.	Brand	Model	Infusion Accuracy	Ambient temperature
1	Hanaco	H-06APD-8	±4%	+10°C ~ +40°C
2	JR	Automatic Vent Type With Needle	±4%	+10°C ~ +40°C
3	Kindly	ordinary type with needle	±4%	+10°C ~ +40°C
4	Kangjin	IS-F-C3F	±4%	+10°C ~ +40°C
5	Shinva	ordinary type with needle	±4%	+10°C ~ +40°C
6	MDK	EF-BS1-P1	±4%	+10°C ~ +40°C

7	Terumo		±4%	+10℃~+40℃
---	--------	--	-----	-----------

The consumable used must have a medical device product registration certificate, and the consumable specifications are selected in the same specification as the recommended consumable brand. consumable Installation Methods See 7.3.1 Install/replace consumable.

In order to ensure infusion accuracy, when the ambient temperature changes significantly, the equipment needs to be re-calibrated, calibration method See Section 10 Accuracy Calibration for consumable.

Please strictly follow the requirements described in Section 10 to calibrate and use the consumable when change to a new consumable from a different manufacturer. Otherwise, the infusion accuracy may be compromised.

Consumables should be used in accordance with the IFU, and the following points should be noted:

- infection or microbial hazards such as explants, needles or surgical equipment contaminated with potentially infectious substances of human origin, and
- physical hazards such as from sharps.

12. Technical Specification

1)The methods of controlling Bolus volume before occlusion: The pressure in the occlusion pipeline is released to control the bolus volume by controlling the inversion of the stepper motor.

2)Storage time for the electronic memory after power off: same as the product lifetime.

3)The maximum volume that the pump can deliver under a single

fault condition: 0.4mL.

4) Device calibration is measured in ml.

5) The methods used to avoid overflow or underflow due to device failure: to prevent overflow or underflow by using drop speed sensor to measure flow rate.

6) The rising curve for HANACO IV infusion set with the minimum flow rate during the first two hours of operation.

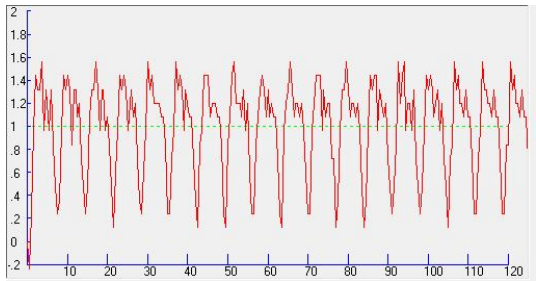

In the above figure, the dashed line shows the set flow rate (1 mL/h in this figure), and the solid line is the continuous connection line for the average flow rate during a sampling period.

7) The rising curve for HANACO IV infusion set with the intermediate flow rate during the first two hours of operation

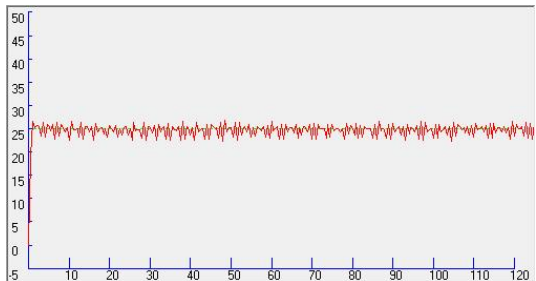

In the above figure, the dashed line shows the set flow rate (25 mL/h in this figure), and the solid line is the continuous connection line for the average flow rate during a sampling period.

8)The trumpet curve for HANACO IV infusion set with the minimum flow rate during the two hour of operation, which was plotted based on the test data gathered during the two hours of operation.

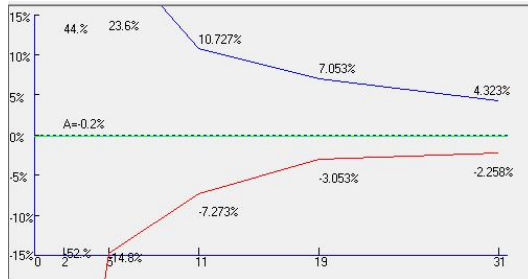

The dashed line in green color is the final value that the infusion error of the device is eventually converging to. The solid blue line above the dashed line is the maximum positive deviation during the second hour of operation. The solid red line below the dashed line is the maximum negative deviation during the second hour of operation.

9)The trumpet curve for HANACO IV infusion set with the intermediate flow rate, which was plotted based on the test data gathered during the second hour of operation.

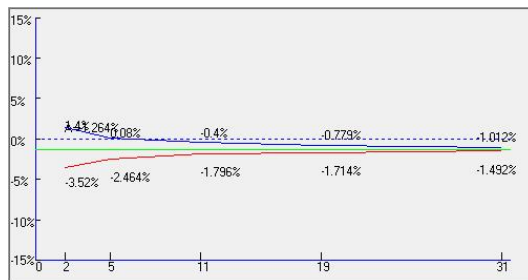

The dashed line in green color is the final value that the infusion error of the device is eventually converging to. The solid blue line above the dashed line is the maximum positive deviation during the second hour of operation. The solid red line below the dashed line is

the maximum negative deviation during the second hour of operation.

10)The sensitivity of the air-in-line sensor: the minimum air bubble size that can be detected is 25 uL.

13. Restore to factory setting

Default factory setting as below:

No.	Parameter	Factory presets
1	Brightness level	Level 3
2	System sound level	Level 3
3	Bubble level	Level 3
4	Night mode sound level	Level 3
5	Night mode brightness level	Level 3
6	Occlusion pressure level	120 kPa
7	Night mode	Close
8	WI-FI	Close
9	Infusion mode	Rate mode
10	KVO	Constant KVO
11	KVO rate	1.00 mL
12	Call Back Time	2 min
13	Near End Of Infusion time	5 min
14	Auto screen lock time	5 min
15	Night mode start time	19:00:00
16	Night mode end time	09:00:00
17	Bolus rate	1200.00 mL/h
18	Purge rate	1200.00 mL/h
19	Bolus volume	5.00 mL
20	Purge volume	15.00 mL

14. Use, Maintenance and Removal of the Internal Battery

The device has an internal rechargeable lithium battery with the following specification: 21700/4800mAh*2PCS.

Daily maintenance of the battery:

When the pump is not used for a long time, the internal battery should be fully charged at least once for every 3 months by connecting the device to the mains power to help saving the battery life.

Contact the customer service immediately if the internal battery cannot be charged or cannot work normally. Do not disassemble it by yourself. For the healthcare providers who have the ability to repair a device, we will provide training to the related personnel from these facilities.

The battery is maintained and replaced as shown in the figure below.

The device has a internal disposable button battery designed to last longer than 8 years, when the set time is exceeded, need to be disposed with the device in accordance with the instructions for waste disposal in this manual 16.

15. Service and Maintenance

Check the pump before use:

1) Check whether there are foreign objects inside the power outlet (such as drug solution residue), and confirm that the device startup self-test is normal.

2) Select the correct IV infusion set specification, check the battery power, and charge it in time when the power is low.

During use:

1) To avoid giving an incorrect dosage of drug to a patient, please disconnect the pump from the patient before changing a device.

2) Please make sure that the infusion line is not kinked. Insert the needle to the vein on a part of the patient's body where it is not likely to be squeezed or pressed.

3) To prevent the spilled drug solution on the pump surface from getting into the inside of the device, wipe it dry immediately if there is a spill.

Storage and daily maintenance:

1) To keep the device clean, wipe it clean for at least once a month, which can prevent the corrosion caused by the drug solution and avoid the mobility of the mechanical parts being affected by the dried solution.

2) Use a clean and damp cloth or an alcohol pad to wipe clean the device. Take caution to avoid any liquid from entering the device. If disinfection is required, commonly used disinfectants can be used. After using the disinfectant, after wetting with a soft cloth in water, wring out the soft cloth for scrub treatment. When using disinfectants, follow their instructions.

3) Check the Low battery Alarm time of the device at least once a month. Make the device standby when the battery is low in non-clinical use, start timing when you hear the alarm of "low battery", and the alarm time should be more than 30 minutes.

4) Keep the surface of the air bubble sensor probe clean. A dirty probe will reduce the sensor's sensitivity in air bubble detection or cause false alarm. Take caution when cleaning the probe to avoid causing any damage.

16. Waste Disposal

16.1. Battery

Please follow local regulations to dispose of used batteries.

16.2. IV infusion set

After use, please dispose of the IV infusion set in accordance with the relevant medical waste disposal regulations.

16.3. Infusion pump

This device is designed to last 8 years and should be scrapped after it has exceeded the lifetime. End-of-life Infusion pumps can be sent back to the dealer who sold the product or to the Company for proper recycling.

17. Electromagnetic Compatibility

Special precautions regarding Electromagnetic Compatibility (EMC) are required for this equipment. Must install and use in accordance with the electromagnetic compatibility information specified in this instruction.

Portable and mobile RF communication devices may have an impact on this device.

Must use the cables and accessories provided by this device, and the cable information as follows:

The name of the cable	Length
The power adapter	2.9 m

In addition to cables (transducers) sold as spare parts for internal components, the use of accessories and cables (transducers) other than specified may result in an increase in equipment or system

emission or a decrease in immunity.

Devices or systems should not be used close to or stacked with other devices, and if they must be accessed or stacked, observe to verify that they can run normally in the configuration they are using.

The basic performance is to operate on a network power supply (including an internal battery) connection.

Name	Specific Description
The network power supply (including the internal battery) is connected to run	At the intermediate rate of 25.00mL/h and the VTBI of $\geq 10\text{mL}$, start to operation, infusion accuracy error less than $\pm 4\%$ and the operation is normal during the process, there should be no abnormal phenomena and failures.

Note : The emissions characteristics of this equipment make it suitable for use in industrial areas and hospitals (CISPR 11 class A). If it is used in a residential environment (for which CISPR 11 class B is normally required) this equipment might not offer adequate protection to radio-frequency communication services. The user might need to take mitigation measures, such as relocating or re-orienting the equipment.

Guidance and manufacture's declaration – electromagnetic emission	
The Infusion pump Graseby 1500 is intended for use in the electromagnetic environment specified below. The customer or the user of the Infusion pump Graseby 1500 should assure that it is used in such and environment.	
Emissions test	Compliance
RF emissions CISPR 11	Group 1
RF emissions CISPR 11	Class A
Harmonic emissions IEC 61000-3-2	Not applicable
Voltage fluctuations / flicker emissions IEC 61000-3-3	Not applicable

Guidance and manufacture's declaration – electromagnetic immunity		
The Infusion pump Graseby 1500 is intended for use in the electromagnetic environment specified below. The customer or the user of Infusion pump Graseby 1500 should assure that it is used in such an environment.		
Immunity test	IEC 60601 test level	Compliance level

Electrostatic discharge (ESD) IEC 61000-4-2	±8 kV contact ±2 kV, ±4 kV, ±8 kV, ±15 kV air	±8 kV contact ±2 kV, ±4 kV, ±8 kV, ±15 kV air
Electrical fast transient/burst IEC 61000-4-4	±2 kV for power supply lines ±1 kV signal input/output 100kHz repetition frequency	±2 kV for power supply lines Not Applicable 100kHz repetition frequency
Surge IEC 61000-4-5	±0.5kV,±1 kV differential mode ±0.5kV,±1 kV,±2 kV common mode	±0.5kV,±1 kV differential mode Not Applicable
Voltage dips, short interruptions and voltage variations on power supply input lines IEC 61000-4-11	0 % UT; 0,5 cycle At 0°, 45°, 90°, 135°, 180°, 225°, 270° and 315°. 0 % UT; 1 cycle and 70 % UT; 25/30 cycles; Single phase: at 0°. 0 % UT; 250/300 cycle	0 % UT; 0,5 cycle At 0°, 45°, 90°, 135°, 180°, 225°, 270° and 315°. 0 % UT; 1 cycle and 70 % UT; 25/30 cycles; Single phase: at 0°. 0 % UT; 250/300 cycle
Power frequency (50/60Hz) magnetic field IEC 61000-4-8	30 A/m 50Hz/60Hz	30 A/m 50Hz/60Hz
Note: U_T is the a.c. mains voltage prior to application of the test level.		

Guidance and manufacture's declaration – electromagnetic immunity		
The Infusion pump Graseby 1500 is intended for use in the electromagnetic environment specified below. The customer or the user of Infusion pump Graseby 1500 should assure that it is used in such an environment.		
Immunity test	IEC 60601 test level	Compliance level
Conducted RF IEC61000-4-6	3 V 0,15 MHz – 80 MHz 6 V in ISM bands between 0,15 MHz and 80 MHz 80%AM at 1 kHz	3 V 0,15 MHz – 80 MHz 6 V in ISM bands between 0,15 MHz and 80 MHz 80%AM at 1 kHz
Radiated RF IEC61000-4-3	3 V/m 80 MHz – 2,7 GHz 80%AM at 1 kHz	3 V/m 80 MHz – 2,7 GHz 80%AM at 1 kHz
NOTE 1 At 80 MHz and 800 MHz, the higher frequency range applies.		
NOTE 2 These guidelines may not apply in all situations. Electromagnetic propagation is affected by absorption and reflection from structures, objects and people.		
^a Field strengths from fixed transmitters, such as base stations for radio (cellular/cordless) telephones and land mobile radios, amateur radio, AM and FM radio broadcast and TV		

broadcast cannot be predicted theoretically with accuracy. To assess the electromagnetic environment due to fixed RF transmitters, an electromagnetic site survey should be considered. If the measured field strength in the location in which the Infusion pump Graseby 1500 is used exceeds the applicable RF compliance level above, the Infusion pump Graseby 1500 should be observed to verify normal operation. If abnormal performance is observed, additional measures may be necessary, such as reorienting or relocating the Infusion pump Graseby 1500.

^b Over the frequency range 150 kHz to 80 MHz, field strengths should be less than 3 V/m.

Guidance and manufacturer's declaration - electromagnetic Immunity

The Infusion pump Graseby 1500 is intended for use in the electromagnetic environment specified below. The customer or the user of the Infusion pump Graseby 1500 should assure that it is used in such an environment

Radiated RF IEC61000 -4-3 (Test specifications for ENCLOSURE PORT IMMUNITY to RF wireless communications equipment)	Test Frequency (MHz)	Band (MHz)	Service	Modulation	IEC 60601-1-2 Test Level (V/m)	Compliance level (V/m)
	385	380 –390	TETRA 400	Pulse modulation 18 Hz	27	27
	450	430 –470	GMRS 460, FRS 460	FM ± 5 kHz deviation 1 kHz sine	28	28
	710	704 – 787	LTE Band 13, 17	Pulse modulation 217 Hz	9	9
	745					
	780					
	810	800 – 960	GSM 800/900, TETRA 800, iDEN 820, CDMA 850, LTE Band 5	Pulse modulation 18 Hz	28	28
	870					
	930					
	1720	1 700 – 1 990	GSM 1800; CDMA 1900; GSM 1900; DECT; LTE Band 1, 3, 4, 25; UMTS	Pulse modulation 217 Hz	28	28
	1845					
	1970					
	2450	2 400	Bluetooth,	Pulse	28	28

		– 2 570	WLAN, 802.11 b/g/n, RFID 2450, LTE Band 7	modulation 217 Hz		
	5240	5 100	WLAN	Pulse	9	9
	5240	–	802.11	modulation		
	5785	5 800	a/n	217 Hz		

NOTE If necessary to achieve the IMMUNITY TEST LEVEL, the distance between the transmitting antenna and the ME EQUIPMENT or ME SYSTEM may be reduced to 1 m. The 1 m test distance is permitted by IEC 61000-4-3.

- a) For some services, only the uplink frequencies are included.
- b) The carrier shall be modulated using a 50 % duty cycle square wave signal.
- c) As an alternative to FM modulation, 50 % pulse modulation at 18 Hz may be used because while it does not represent actual modulation, it would be worst case.

The MANUFACTURER should consider reducing the minimum separation distance, based on RISK MANAGEMENT, and using higher IMMUNITY TEST LEVELS that are appropriate for the reduced minimum separation distance. Minimum separation distances for higher IMMUNITY TEST LEVELS shall be calculated using the following equation:

$$E = \frac{6}{d} \sqrt{P}$$

Where P is the maximum power in W, d is the minimum separation distance in m, and E is the IMMUNITY TEST LEVEL in V/m.

Guidance and manufacturer's declaration - electromagnetic Immunity

The Infusion pump Graseby 1500 is intended for use in the electromagnetic environment specified below. The customer or the user of the Infusion pump Graseby 1500 should assure that it is used in such an environment

Radiated fields in close proximity IEC61000-4-39 (Test specifications for ENCLOSURE PORT IMMUNITY to proximity magnetic fields)	Test Frequency	Modulation	IEC 60601-1-2 Test Level (A/m)	Compliance level (A/m)
	30 kHz	CW	8	8
	134.2 kHz	Pulse modulation 2.1 kHz	65	65
	13.56 MHz	Pulse modulation 50 kHz	7,5	7,5

18. Antistatic Precautions

The Infusion pumps have been tested and comply with medical device standard IEC 60601-1-8.

When using this device, the user should not touch the pins of connectors marked with an electrostatic discharge warning symbol and should not connect to these connectors unless electrostatic discharge precautions are used.

The operator should be aware of the following things:

- a) Unless appropriate preventive measures have already been taken, do not use hand or hand tool to touch connectors with electrostatic discharge warning signs. Preventive measures include: 1) Methods for preventing electrostatic charge accumulation (such as air conditioning, air humidification, floor conductive coating or Non-synthetic clothing); 2) Discharge electrostatic charge from human body to the framework of equipment, or to the ground, or to a large piece of metal; 3) Use a wrist band to connect human body to the equipment or to the ground.
- b) All staff who may be in contact with connectors with electrostatic discharge warning signs should receive training, including all clinical/biomedical engineering and healthcare personnel.
- c) Electrostatic discharge training should include the introduction of static charges in the theory of physics, the voltage that may be produced in normal practice, and the damage to the electronic components caused by the electrostatic charge from an operator. Further, methods for how to prevent electrostatic charge accumulation should be provided, as well as how and why to discharge the electrostatic from human body to the framework of equipment or to the ground, and how to use wrist band to connect someone's body to the equipment or to the ground.

19. Network Security Notes

- 1) User access control mechanism

The user access control of this device adopts the account and

password system, and illegal login is rejected.

- 2) Electronic interfaces (including network interfaces, electronic data interchange interfaces) and their data types and technical characteristics.

The communication interface between the product and the outside is Wi-Fi network communication interface, and the data transmission is encrypted according to the internal data interface protocol defined by the company. The data transmission protocol is TCP protocol.

The data type was device data and did not contain personal patient information.

- 3) Network security feature configuration

When connecting to the incoming LAN, the user should configure the appropriate firewall, intrusion prevention equipment, anti-ddos attack system, Internet behavior analysis system, vulnerability scanner, log audit system and other security reinforcement facilities for the LAN to ensure the network security.

- 4) Data backup and disaster recovery

System Settings stored in FLASH can be saved for hundreds of years. The system log is recommended that users regularly download and save it to the computer system using the supporting infusion monitoring information system for subsequent audit.

- 5) Operating environment (including hardware configuration, external software environment, network environment, if applicable)

Hardware configuration: The company's electronic circuit based on the ARM architecture chip processor;

Software environment: Embedded software system;

Network conditions: Wi-Fi wireless communication module based on 802.11b/g/n;

6) Security Software compatibility list (if applicable)

This device does not involve anti-virus software, firewall and other security software;

7) External software environment and security software updates (if applicable)

Not applicable, not updated

8) Off-the-shelf Software Inventory (SBOM, if applicable)

No other off-the-shelf software;

20. Packaging and Accessories

The list of recommended accessories for use with this device (single unit) is as follows:

Attachment	Quantity	Unit
User manual	1	Book
Power adapter	1	Set

Other accessories can be found in the packing list.



Legal manufacture: MDKMed Medical Technology Co., Ltd.

Address: 502A, Building 7, No. 22, Xinyan Road, Donghu Street,
Linping District, Hangzhou City, Zhejiang Province, P. R China 311323

After sale service: MDKMed Medical Technology Co., Ltd.

Tel: 400-880-8392

Email: sales@graseby.com

Web: <http://www.graseby.com>

EC	REP
----	-----

European Authorized Representative:

MedNet EC-REP C IIb GmbH

Borkstrasse 10

48163 Münster, Germany